

SMA ATTENUATOR
5 DB 8 GHZ 2W

R411.805.119
Series : **ATTENUATOR**

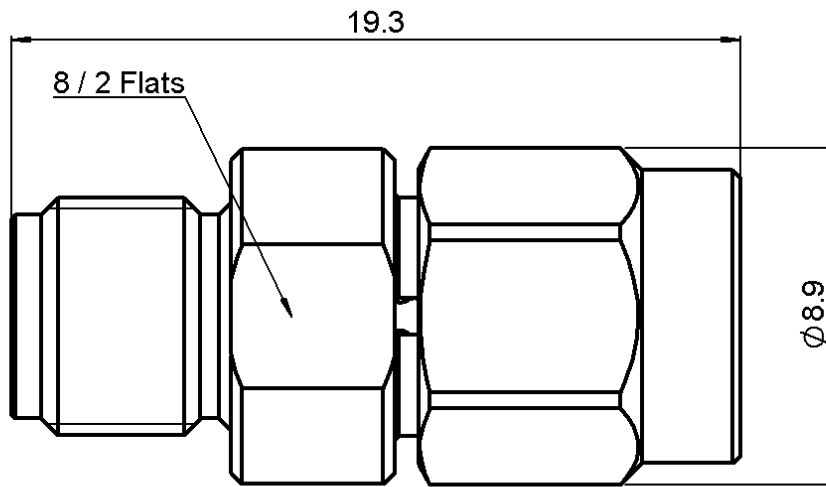

SCALE 1 / 1

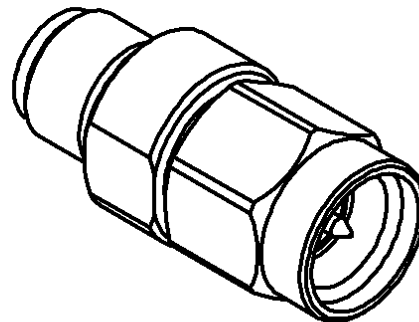

All dimensions are in mm.



COMPONENTS	MATERIALS	PLATING(μm)
BODY	STAINLESS STEEL	PASSIVATION
MALE CENTER CONTACT	BERYLLIUM COPPER	GOLD 2.5 OVER NICKEL 1
FEMALE CENTER CONTACT	BERYLLIUM COPPER	GOLD 2.5 OVER NICKEL 2
OUTER CONTACT		
INSULATOR	PTFE	
GASKET	SILICONE RUBBER	
SUBSTRATE	ALUMINA	
RESISTOR	THIN FILM	
OTHERS PARTS		

Issue : 0834 B

In the effort to improve our products, we reserve the right to make changes judged to be necessary.



SMA ATTENUATOR

5 DB 8 GHZ 2W

R411.805.119

Series : ATTENUATOR

ELECTRICAL CHARACTERISTICS

Frequency (GHz)	DC - 4	4 - 8
V.S.W.R (≤)	1.20	1.25
Deviation(±dB)	0.40	0.50

Operating Frequency Range	DC - 8	GHz
Impedance	50	Ω
Nominal Attenuation	5	dB
Peak power at 25°C (1μs, 1%)	100	W
Average power at 25°C	2	W (Free Air Cooled)
		W (Conduction Cooled)

MECHANICAL CHARACTERISTICS

Connectors	SMA	Male Female	MIL-C 39012
Weight	4,5810 g		

ENVIRONMENTAL CHARACTERISTICS

Operating temperature range	-55 /+125 °C
Storage temperature range	-55 /+125 °C

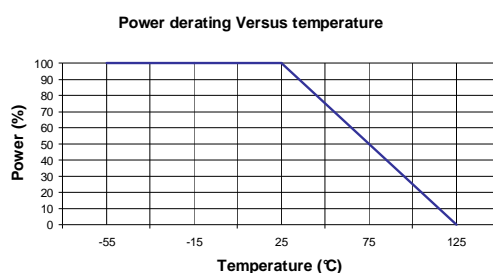

SPECIFICATION

OTHER CHARACTERISTICS

Issue : 0834 B

In the effort to improve our products, we reserve the right to make changes judged to be necessary.

